

3500

Pedestal Mounted Drinking Fountain



FEATURES & BENEFITS

Barrier-Free

Barrier-free capabilities combined with its ease of use allows for a number of installation location possibilities.

Drain Clean-Out

Top-down access to the drain allows the fountain to be cleaned without taking the unit apart, which is ideal for outdoor settings that are high in drain-clogging sediment like leaves, garbage, and other debris.

Construction

Superior strength and durability are achieved with the use of 12 gauge Type 304 Stainless Steel, along with integral 3/8" thick cast stainless bowls. The unit is trimmed with a glossy green powder-coat finish and it is secured to the ground with an integral mounting plate.

Accessibility

Ease of maintenance is achieved with the use of an extra-large access door supplied with heavy-duty door hinges, and is locked by square key pins.

Push Button

With its patented (Pat.# 6,981,692) push-button valve assembly which allows for front access stream adjustment as well as cartridge and strainer access, this fountain offers the ultimate in ease of maintenance.

Bubbler Head

Polished chrome-plated brass bubbler head features an integral basin shank for added strength, and is equipped with a shielded, anti-squirt orifice that provides a steady sanitary source of water.



OPTIONS

- Hose Bib: Model 6236, chrome-plated wheel handled operated compression hose bib with vacuum breaker.
- Hose Bib: Model 6236LD, chrome-plated wheel, handle operated compression hose bib with vacuum breaker. Mounted on pedestal access door with protective housing with lockable door.
- Bib Faucet: Model 6235, chrome-plated, ADA compliant, self-closing, lever operated bib faucet.
- Bib Faucet: Model 6235LD, chrome-plated, ADA compliant, self-closing, lever operated bib faucet. Mounted on pedestal access door with protective housing with lockable door.

To see all options for this model, visit www.hawscos.com.

SPECIFICATIONS

Model 3500 StreetSmart "Hi-Lo" barrier-free vandal-resistant pedestal drinking fountain shall include a 12 gauge Type 304 Stainless Steel pedestal with integral 3/8" thick cast stainless steel basins all with powder-coated green, push-button operated valves with front-accessible cartridge and flow adjustment, polished chrome-plated brass vandal-resistant bubbler heads, polished chrome-plated brass vandal-resistant waste strainers with top-down clean-out access, large access door with heavy duty hinges and square key locks, vandal-resistant bottom plate, integral mounting plate, and 1-1/2" slip waste.

APPLICATIONS

Taking performance and protection to a whole new level is the StreetSmart™ series drinking fountain. This unique drinking fountain is the perfect addition to parks, rest areas, and correctional facilities where vandalism may be more prone to take place. By welding the bowls directly to the upright, they become one with the unit, preventing removal. That, in addition to many other vandal-resistance features, makes this fountain virtually indestructible. This series fountain may also be applicable in a wide assortment of other places not mentioned due to its great appeal through its vandal proof and wheelchair accessible design.

Model meets all current Federal Regulations for the disabled including those in the Americans with Disabilities Act. Haws manufactures drinking fountains, electric water coolers and electric drinking fountains to be lead-free by all known definitions including ANSI/NSF Standard 61, Section 9, California Proposition 65, and the Federal Safe Drinking Water Act.



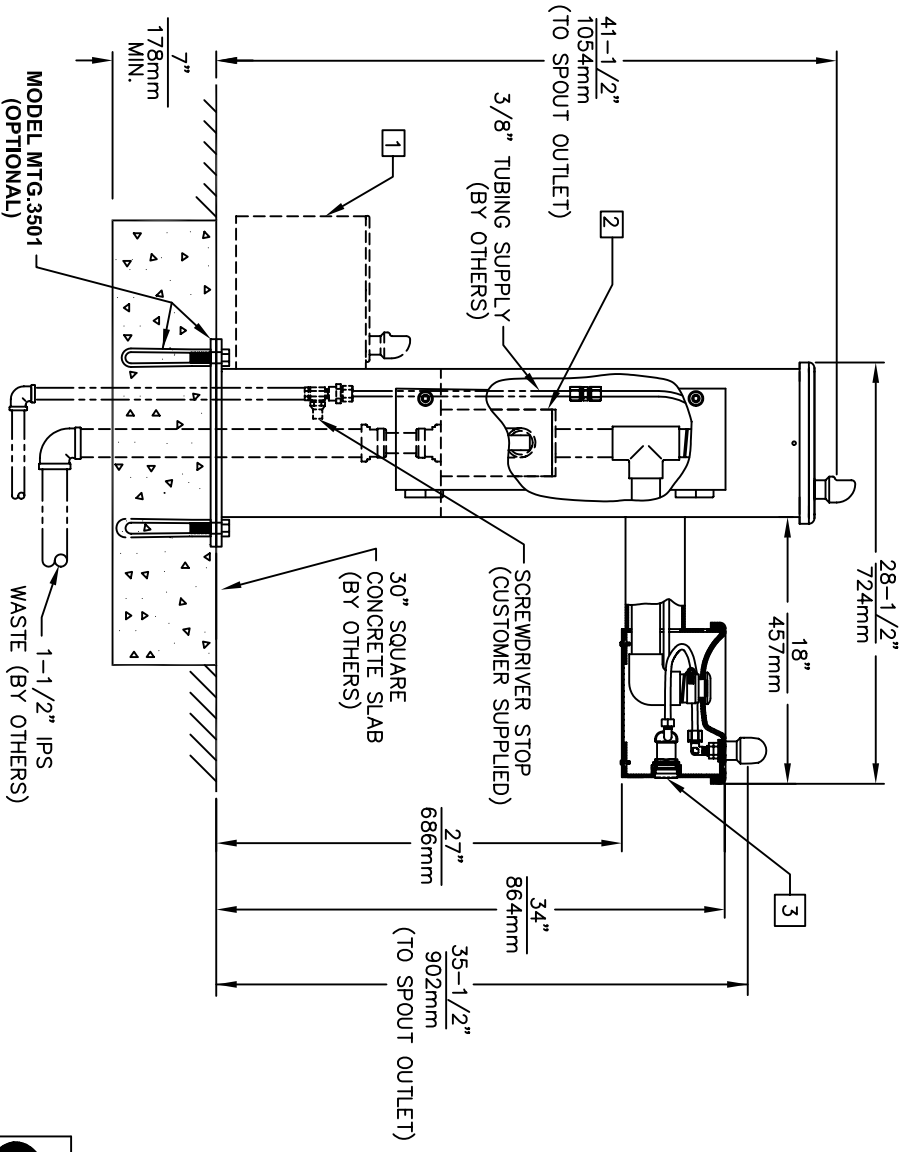
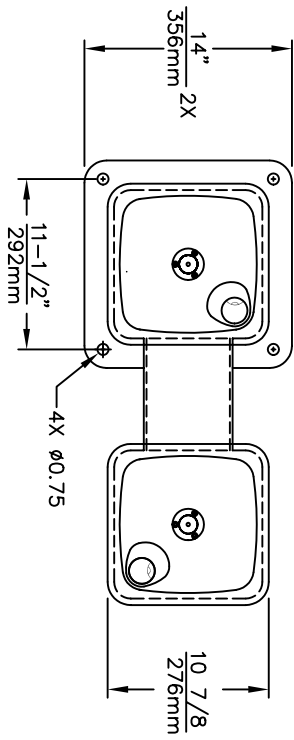

MODEL MTG.3501
(OPTIONAL)
OR
MODEL MTG.3500
(OPTIONAL)

- NOTES:**
1. PET FOUNTAIN IS STANDARD FOR MODEL 3500D ONLY. SEE MODEL 6640 INSTRUCTIONS FOR PLUMBING.
 2. SAND TRAP MODEL 6635 W/ MOUNTING PLATE (OPTIONAL). SEE MODEL FOR INSTALLATION INSTRUCTIONS.
 3. REFER TO 5874/YRK5874 OPERATION AND MAINTENANCE MANUAL FOR PUSH BUTTON AND VALVE INSTALLATION/MAINTENANCE INSTRUCTIONS.
 4. ACCESS DOOR SPECIFIED BY CUSTOMER AND SHIPPED SEPARATELY UNDER THE FOLLOWING MODEL NUMBERS:

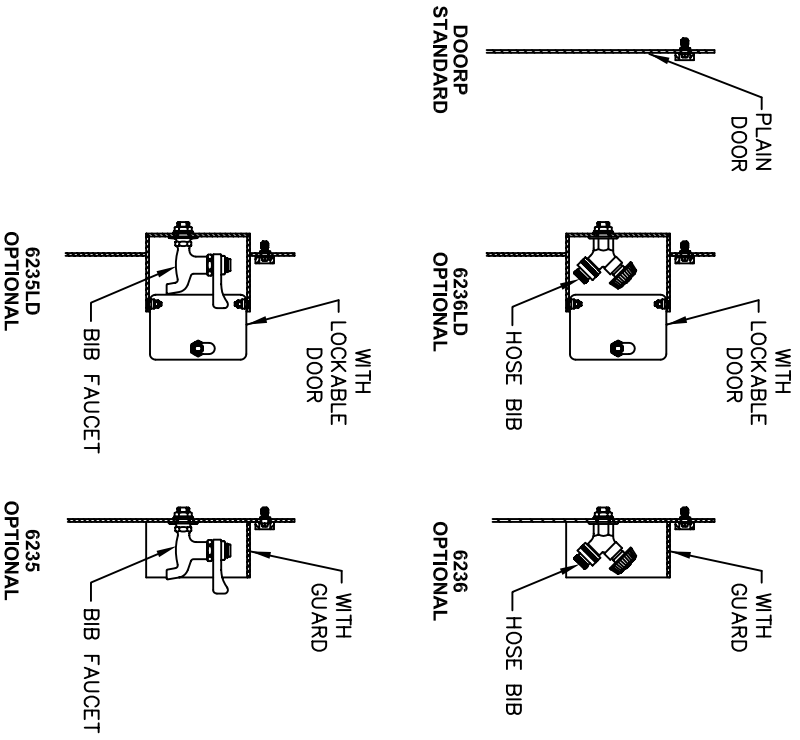

Haws Corporation

INFO FAX : 1-888-FAX-HAWS (1-888-329-4297)

1455 Kiappa Ln, Sparks NV, 89431
Phone: 775-359-4712 Fax: 775-359-7424
Haws Ag Building 3 CH-3401 Burgdorf Switzerland 729531
Haws Ming Pte Ltd 74 Sungai Kodut Loop Singapore 729531
e-MAIL: Haws@hawsco.com Website: www.hawsco.com

REG. NO.	REG. DATE	REG. EXPIRES	MODEL(S)
ECN: 3478	02/04/99	02/04/00	3500/3500D
DATE	DATE	DATE	INFO FAX DOC # 23500/235003
APPROVER	SCALE: 1:15	DRAWING TYPE: INSTALLATION/FABRICK	

CO. NO. 13962000
DATE 02/07/2000
SIZE A 1 SHEET 1 OF 1



INSTALLATION, OPERATION & MAINTENANCE INSTRUCTIONS

1455 Kleppe Lane ♦ Sparks, NV 89431-6467 ♦ (775) 359-4712 ♦ Fax (775) 359-7424
HAWS AG ♦ Bachweg 3 ♦ CH-3401 Burgdorf ♦ Switzerland
Haws Mfg. Pte Lt. ♦ 2A Sungei Kadet Drive ♦ Singapore 729554
Avlis-Avenida Senador, Testonio Vilela ♦ 505 Jardim Aeroporto ♦ Itu, S.P. 13304-550 ♦ Brasil
E-mail: haws@hawsco.com ♦ website: www.hawsco.com

No. 2077448(10)

Model 3500/3500D Drinking Fountain

NOTE TO INSTALLER: Please leave this information with the Maintenance Department.

LIMITED WARRANTY

HAWS® warrants that all of its products are guaranteed against defective material or poor workmanship for a period of **one year from date of shipment**. HAWS liability under this warranty shall be discharged by furnishing without charge F.O.B. HAWS Factory any goods, or part thereof, which shall appear to the Company upon inspection to be of defective material or not of first class workmanship, provided that claim is made in writing to company within a reasonable period after receipt of the product. Where claims for defects are made, the defective part or parts shall be delivered to the Company, prepaid, for inspection. HAWS will not be liable for the cost of repairs, alterations or replacements, or for any expense connected therewith made by the owner or his agents, except upon written authority from HAWS, Sparks, Nevada. HAWS will not be liable for any damages caused by defective materials or poor workmanship, except for replacements, as provided above. Buyer agrees that Haws has made no other warranties either expressed or implied in addition to those above stated, except that of title with respect to any of the products or equipment sold hereunder and that HAWS shall not be liable for general, special, or consequential damages claimed to arise under the contract of sale. The drinking fountain manufactured by HAWS is warranted to function if installation and maintenance instructions provided are adhered to. The units also must be used for the purpose for which they were intended.

NO OTHER WARRANTIES EXPRESSED OR IMPLIED ARE AUTHORIZED, PROVIDED OR GIVEN BY HAWS.

SHOULD YOU EXPERIENCE DIFFICULTY WITH THE INSTALLATION OF THIS MODEL, PLEASE CALL:

1-800-766-5612

FOR PARTS CALL:

1-800-758-9378

**(U.S.A. AND CANADA ONLY) MONDAY-THURSDAY: 6:00 A.M. – 4:00 P.M. PST
FRIDAY: 6:00 A.M – 1:00 P.M. PST**

RECOMMENDED TOOLS: Hack saw, pipe joint sealant, screwdriver, level, 12" adjustable wrench, 10" pipe wrench, 5/32" pinned hex key wrench (supplied), 9/16", 1/2", 7/16" socket wrench or open- end wrench.

LOCATION OF UNIT: The Model 3500/3500D/3500D Drinking Fountain is a wheelchair accessible drinking water facility. The height dimensions shown, meet current ADA requirements. When installing this unit, local, state or federal codes should be adhered to. If height other than shown is required, then dimensions must be adjusted accordingly.

SUPPLY LINE: The minimum recommended line size is 1/2"IPS with 30-90 psi (2-6 ATM) flowing pressure. Where sediment or mineral content is a problem, an inlet filter is recommended.

PLUMBING CONNECTIONS: Inlet is 3/8"O.D. compression fitting. Waste outlet is female 1-1/2" slip PVC pipe.

MAINTENANCE: Periodically clean the strainer. Refer to 5874 Valve Operation and Maintenance Sheet for more information.

TROUBLESHOOTING

PROBLEM	REPAIR CHECKLIST
1. Insufficient bubbler flow.	1a. Check that inlet screwdriver stop valve is wide open. b. Verify minimum 30 psi flowing supply pressure. c. Clean inlet strainer. See 5874 Valve Manual. d. Adjust valve to increase flow. Use front adjust screw or see 5874 Valve Manual.

PARTS BREAKDOWN

ITEM	DESCRIPTION
1	SPANNER WRENCH P/N 0006983506
2	BOTTOM PLATE PBM1035
3	STRAINER 6452
4	BUBBLER HEAD 5703M
5	PUSH BTN ASS'Y PBA7
6	VALVE 5874
7	DOOR KEY, TEE 0002049640
8	KEY, 5/32" HEX PINNED P/N 0002981127
9	6635 SANDTRAP (OPTIONAL)
10	MTG.3501 (OPTIONAL)
11	MTG.3500 (OPTIONAL)
12	1/2" STOP ASSY. 6449

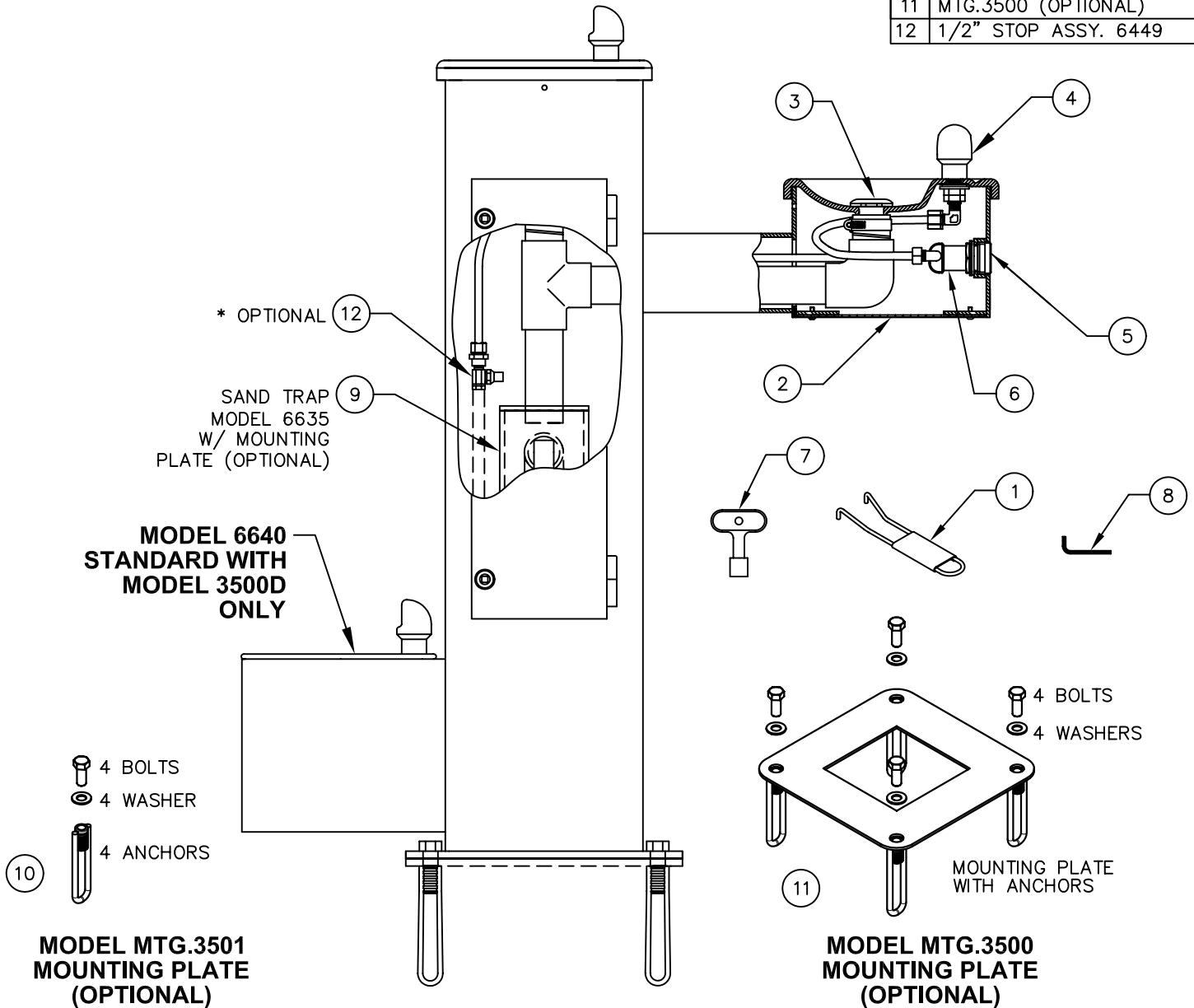

* IF PURCHASED MFG SUGGESTS YOU USE WITH CONNECTOR P/N 0001730150.2

WHEN ORDERING PARTS PLEASE SPECIFY YOUR MODEL NUMBER



Haws
corporation

1455 KLEPPE LANE
SPARKS, NEVADA

BACHWEG 3
CH3401 BURGDORF
SWITZERLAND

DRAWN BY: F.V.	DATE: 02/04/99	CHECK BY:	APP'D BY:	SCALE: 1/4
TITLE: 3500/3500D			PART NUMBER: 0002077448	
DRAWING TYPE: PARTS BREAKDOWN			DRAWING NUMBER: 13961C00	REV. 10

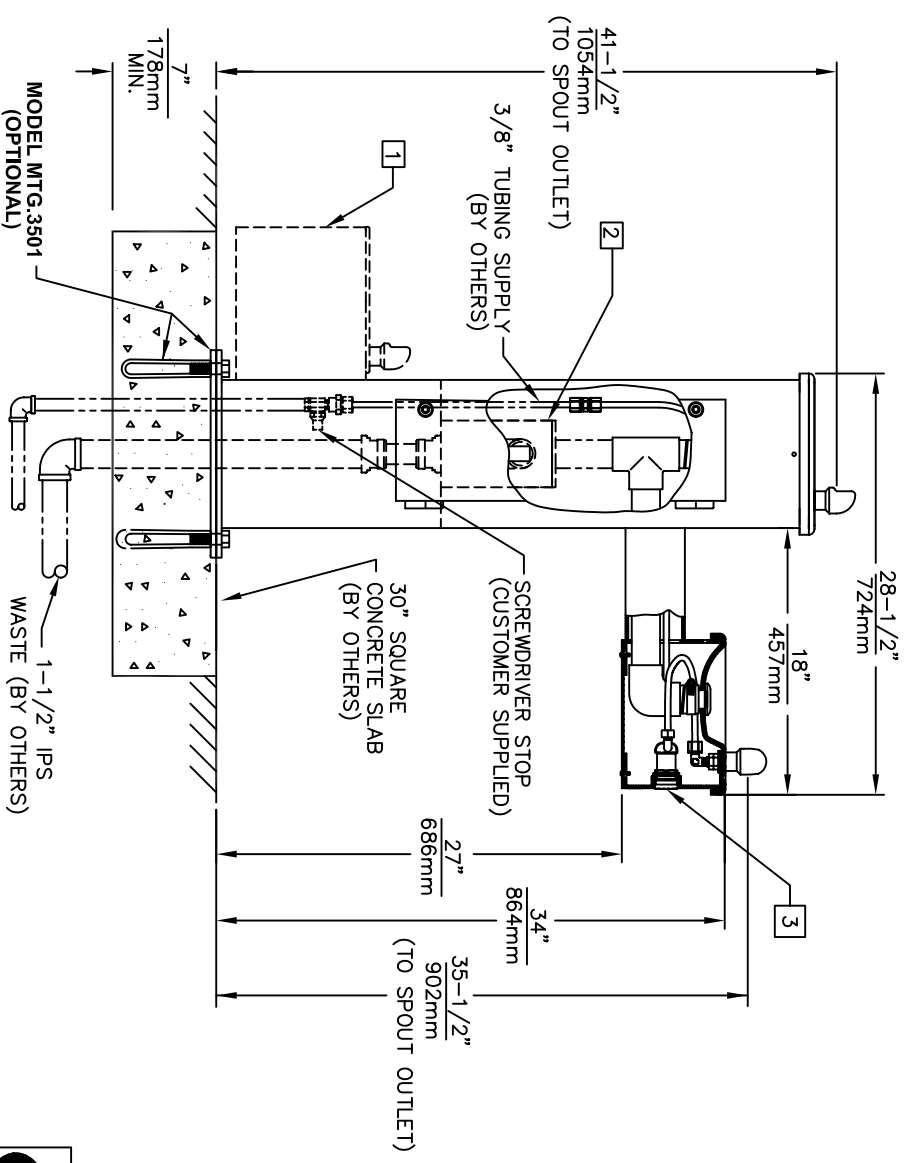
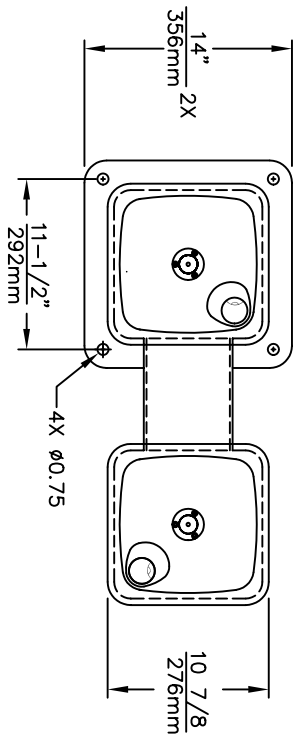

MODEL MTG.3501
(OPTIONAL)
OR
MODEL MTG.3500
(OPTIONAL)

NOTES:

1. PET FOUNTAIN IS STANDARD FOR MODEL 3500D ONLY. SEE MODEL 6640 INSTRUCTIONS FOR PLUMBING.
2. SAND TRAP MODEL 6635 W/ MOUNTING PLATE (OPTIONAL). SEE MODEL FOR INSTALLATION INSTRUCTIONS.
3. REFER TO 5874/YRK5874 OPERATION AND MAINTENANCE MANUAL FOR PUSH BUTTON AND VALVE INSTALLATION/MAINTENANCE INSTRUCTIONS.
4. ACCESS DOOR SPECIFIED BY CUSTOMER AND SHIPPED SEPARATELY UNDER THE FOLLOWING MODEL NUMBERS:

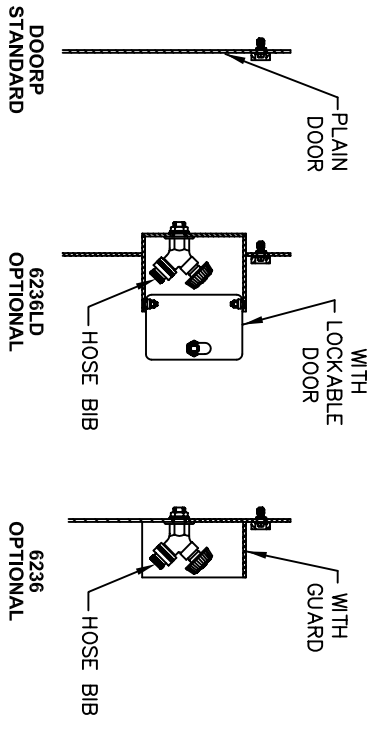

Haws Corporation

INFO FAX : 1-888-FAX-HAWS (1-888-329-4297)

1455 Kiappa Ln, Sparks NV 89431
Phone: 775-359-4712 Fax: 775-359-7424

Haws AG Buchweg 3 CH-3401 Burgdorf Switzerland
Haws Ming Pte Ltd 74 Sungai Kodut Loop Singapore 729531
e-MAIL: Haws@hawsco.com Website: www.hawsco.com

REG. NO.	REG. DATE	REG. EXPIRES	MODEL(S)
ECN: 3478	02/04/99		3500/3500D
DATE	DATE	SCALE: 1:15	INFO FAX DOC # 23500/235003
APPROVER	DATE	DRAWING TYPE	INSTALLATION/FABRICK

PROJ. NO.	DATE	SIZE
02077448 D	1396200	A 1 SH 1 OF 1