

SF-3200

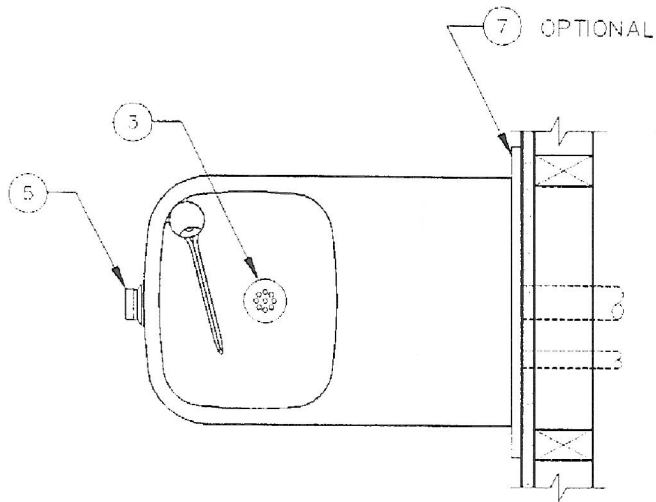

*When ordering parts
please specify your
model number.*

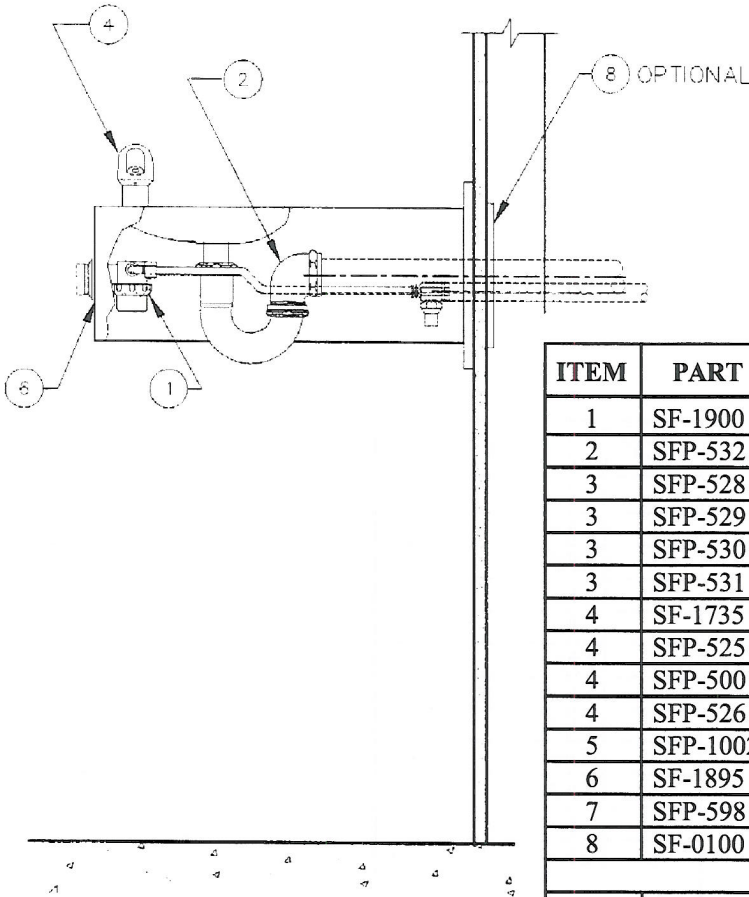

ITEM	PART #	DESCRIPTION
1	SF-1900	In-Line Strainer
2	SFP-532	Trap 1 1/2"
3	SFP-528	Drain Strainer
3	SFP-529	Lock Nut
3	SFP-530	Brass Washer
3	SFP-531	Rubber Washer
4	SF-1735 SLT	Bubbler Head
4	SFP-525	Lock Washer
4	SFP-500	Rubber Washer
4	SFP-526	Fiber Washer
5	SFP-1002	Push Button Valve
6	SF-1895	Valve
7	SFP-598	Stainless Steel Back Plate
8	SF-0100	Mounting Plate
Parts Not Shown		
	SFP-527	Spud .45 G.P.M.
	SFP-509	Elbow 3/8" x 1/4" ml cmp
	SFP-533	3/8" Poly Tubing (17")
	SFP-510	Elbow 3/8" x 1/4" f cmp
	SFP-534	Elbow 1/4" x 1/4" f
	SFP-536	Bowl

For models marked C/F, please contact factory.