

SF-7300

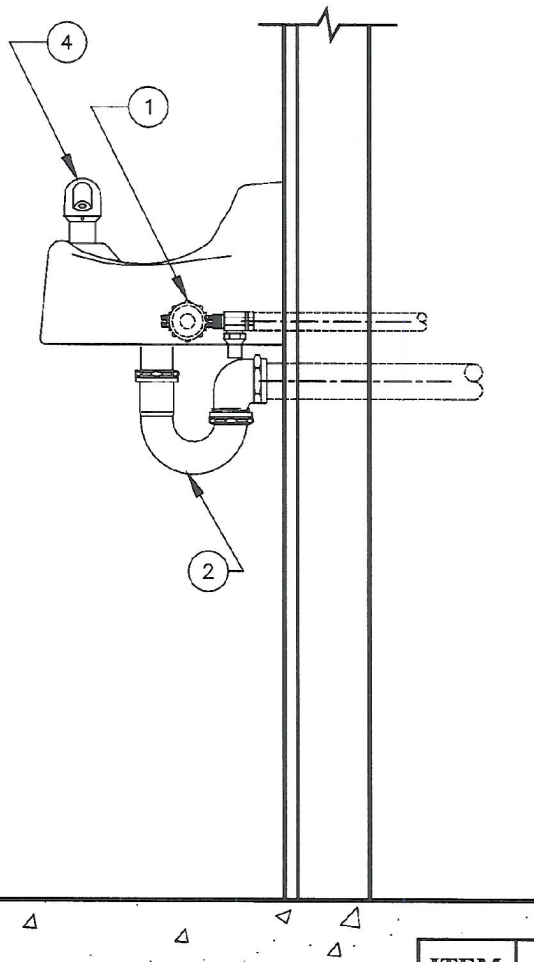
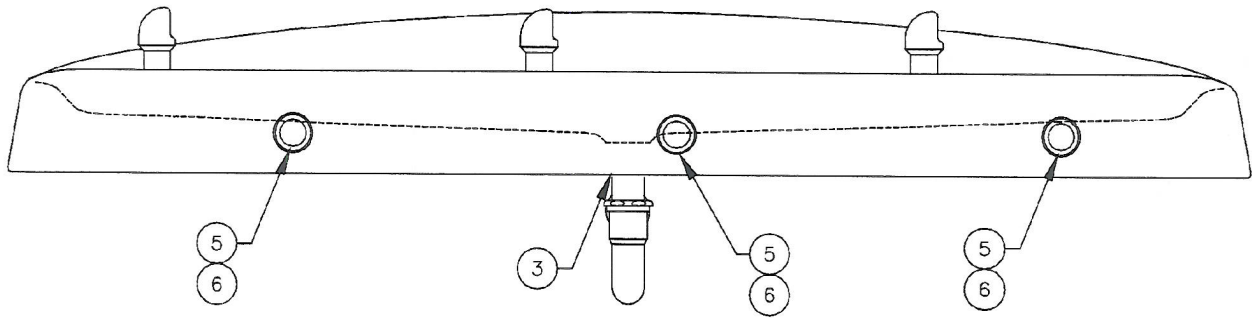

*When ordering parts
please specify your
model number.*

ITEM	PART #	DESCRIPTION
1	SF-1900	In-Line Strainer
2	SFP-532	Trap
3	SFP-1203	Drain Assembly
4	SF-1725	Bubbler Head
5	SFP-1004	Push Button
6	SF-1895	Valve